

-  Clean water
-  Domestic use
-  Civil use



INSTALLATION AND USE

GPW is a pre-assembled system designed to connect to water mains or a primary collection tanks. It provides water supply and pressurization and is ideal for residential, commercial, and public buildings. It's also suitable for hotels, park irrigation, as well as industrial water handling and treatment.

GPW is compatible with clean water and aqueous solutions that do not chemically or mechanically harm the materials used and are free from abrasive or fibrous substances.

PRODUCT DESCRIPTION

GPW is a variable speed pressurization system **comprising two or three pumps** assembled into one unit. It is electronically controlled by two or three **STEADYPRES** devices connected in parallel. These devices automatically adjust the pump operation based on the system's varying water demands, ensuring constant pressure.

When water withdrawal reduces the system pressure, the first pump activates to meet the required flow rate, maintaining pressure at the set value. As the maximum rotation speed is reached, additional pumps start up in sequence to fulfill the system's water demand.

COMPONENTS

- ※ **Pumps** connected in parallel via suction and discharge manifolds. Each pump is equipped with a ball valve on the suction side and a ball valve and non-return valve (integrated in STEADYPRES) on the discharge side.
- ※ **BASE** made of metal profile and equipped with adjustable vibration-damping feet.
- ※ **STEADYPRES ELECTRONIC DEVICES** installed directly on the delivery pipe of each individual pump. They continuously regulate the rotation speed, ensuring a constant pressure even as user demands fluctuate. Each inverter can manage the alternating operation of pumps as needed.

GPW is designed to protect the system from:

- ※ Dry running
- ※ overvoltage and undervoltage
- ※ **CONTROL PANEL** equipped with magnetothermal motor protection circuit breakers for three-phase versions, and magnetothermal circuit breakers for single-phase versions.



GP2W – 5CR

Pressurization units comprising two multistage centrifugal pumps equipped with STEADYPRES inverters capable of maintaining a constant pressure in the system. The GP2W - 5CR are suitable for domestic and residential water supply, garden irrigation, and general clean water handling.

TECHNICAL DATA

- Liquid temperature up to **+40 °C**
- Ambient temperature between **0 °C** and **+40 °C**
- Max. pressure in the pump body **7 bar**
- Continuous running duty **S1**



GP2W – MK

Pressurization units comprising three vertical multistage pumps equipped with STEADYPRES inverters, capable of maintaining constant pressure in the system. GP3W - MK are suitable for residential, commercial, and public water supply, large-scale irrigation, and handling clean water in general.

TECHNICAL DATA

- Liquid temperature up to **+40 °C**
- Ambient temperature between **0 °C** and **+40 °C**
- Max. pressure in pump body **10 bar**
- Continuous running duty **S1**



GP3W – MK

Pressurization units comprising three vertical multistage pumps equipped with STEADYPRES inverters capable of maintaining constant pressure in the system. GP3W - MK are suitable for residential, commercial, and public water supply, large-scale irrigation, and handling clean water in general.

TECHNICAL DATA

- Liquid temperature up to **+40 °C**
- Ambient temperature between **0 °C** and **+40 °C**
- Max. pressure in pump body **10 bar**
- Continuous running duty **S1**

GP2W - 5CR

FIELD AND PERFORMANCE DATA

50 Hz

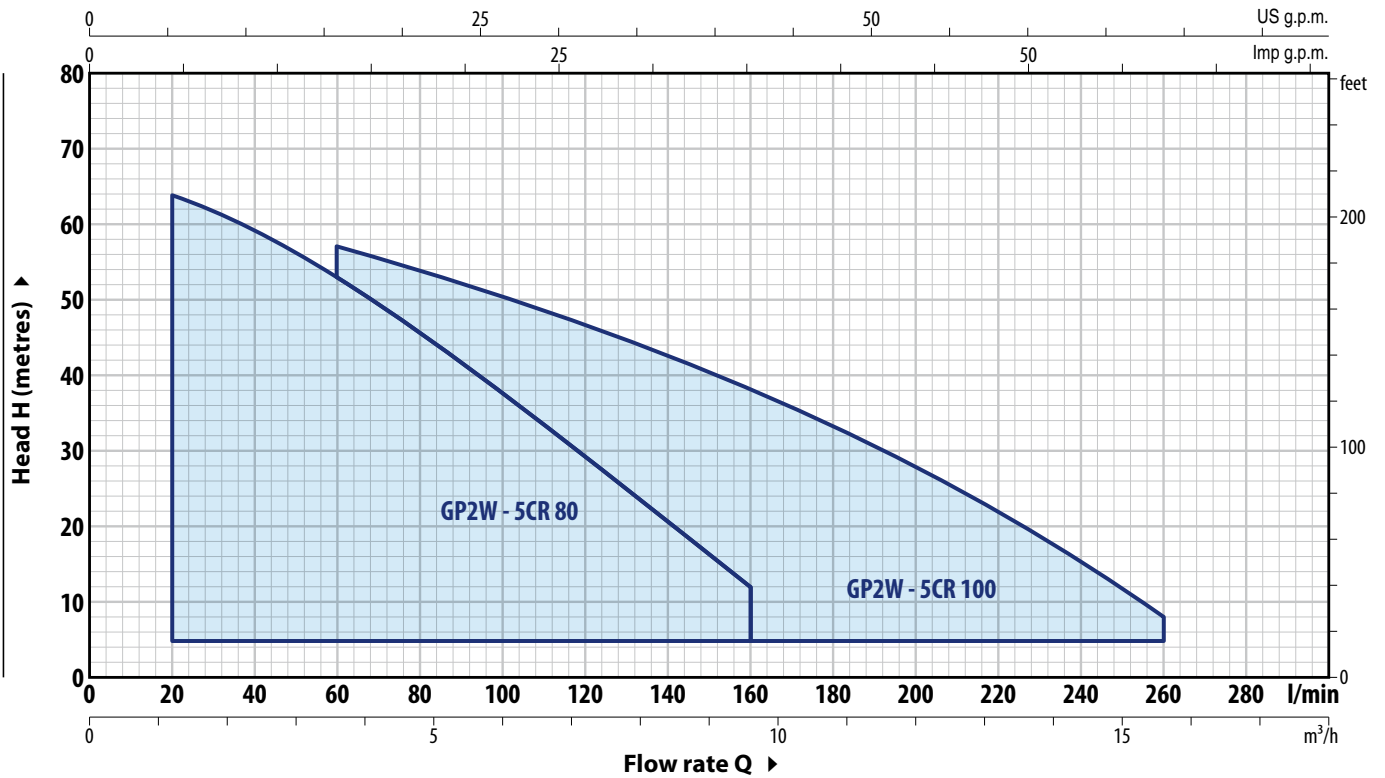

TYPE		POWER P ₂		Q	Flow rate														
Single-phase	Three-phase	kW	HP		m ³ /h	0	1.2	2.4	3.6	4.8	6.0	7.2	8.4	9.6	10.8	12.0	13.2	14.4	15.6
GP2Wm - 5CR 80	GP2W - 5CR 80	2x0.75	2x1	l/min	0	20	40	60	80	100	120	140	160	180	200	220	240	260	
GP2Wm - 5CR 100	GP2W - 5CR 100	2x0.9	2x1.25	H metres	67	64	59	53	45.5	37.5	29.5	20.5	12						
					63	61.5	59.5	57	53.5	50.5	46.5	42.5	38	33	28	22	15	8	

Q = Flow rate H = Total manometric head

✘ The data shown in the diagram and tables indicate performance with 2 pumps in operation

PERFORMANCE CURVES

50 Hz

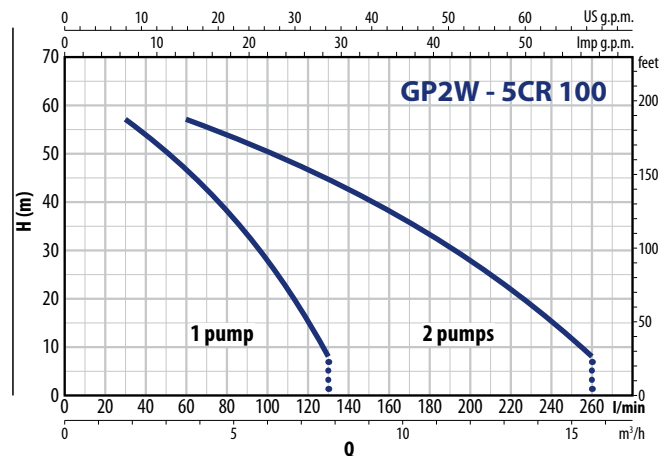
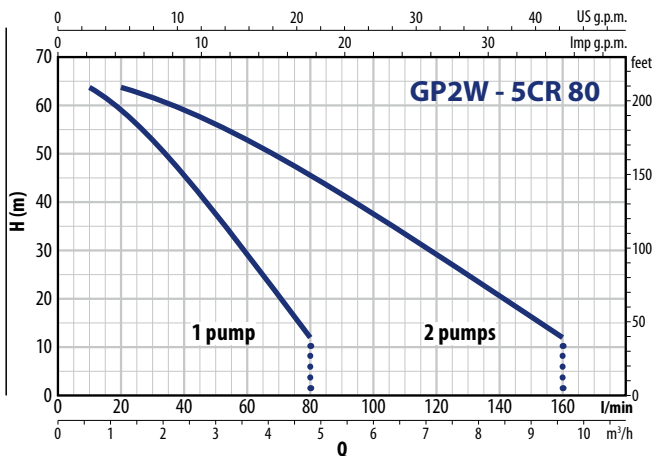

ABSORPTION

TYPE	VOLTAGE
Single-phase	230 V
GP2Wm - 5CR 80	2 x 9.0 A
GP2Wm - 5CR 100	2 x 10.0 A

TYPE	VOLTAGE
Three-phase	400 V
GP2W - 5CR 80	2 x 3.2 A
GP2W - 5CR 100	2 x 3.2 A

DIMENSIONS AND WEIGHT

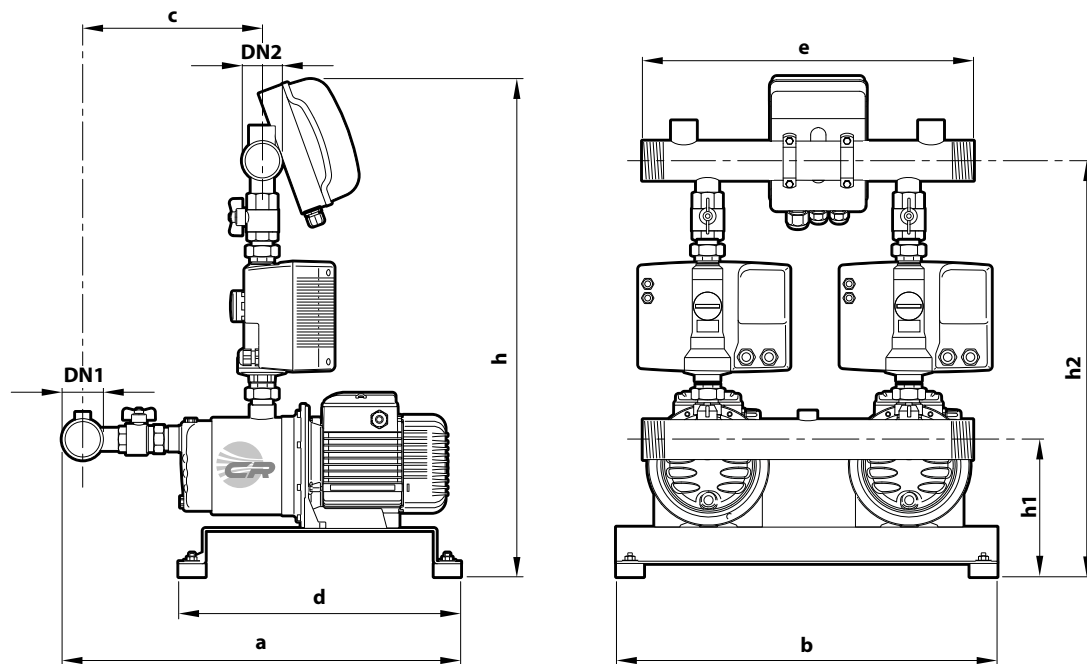

Monofase	TIPO Trifase	BOCCHE		DIMENSIONS mm										kg	
		DN1	DN2	a	b	c	d	e	h		h1	h2		1~	3~
GP2Wm - 5CR 80	GP2W - 5CR 80	1½"	1½"	608	570	273	420	500	754	712	205	624	582	64	67
GP2Wm - 5CR 100	GP2W - 5CR 100	2"		687		347								65	68

GP2W - MK

FIELD AND PERFORMANCE DATA

50 Hz

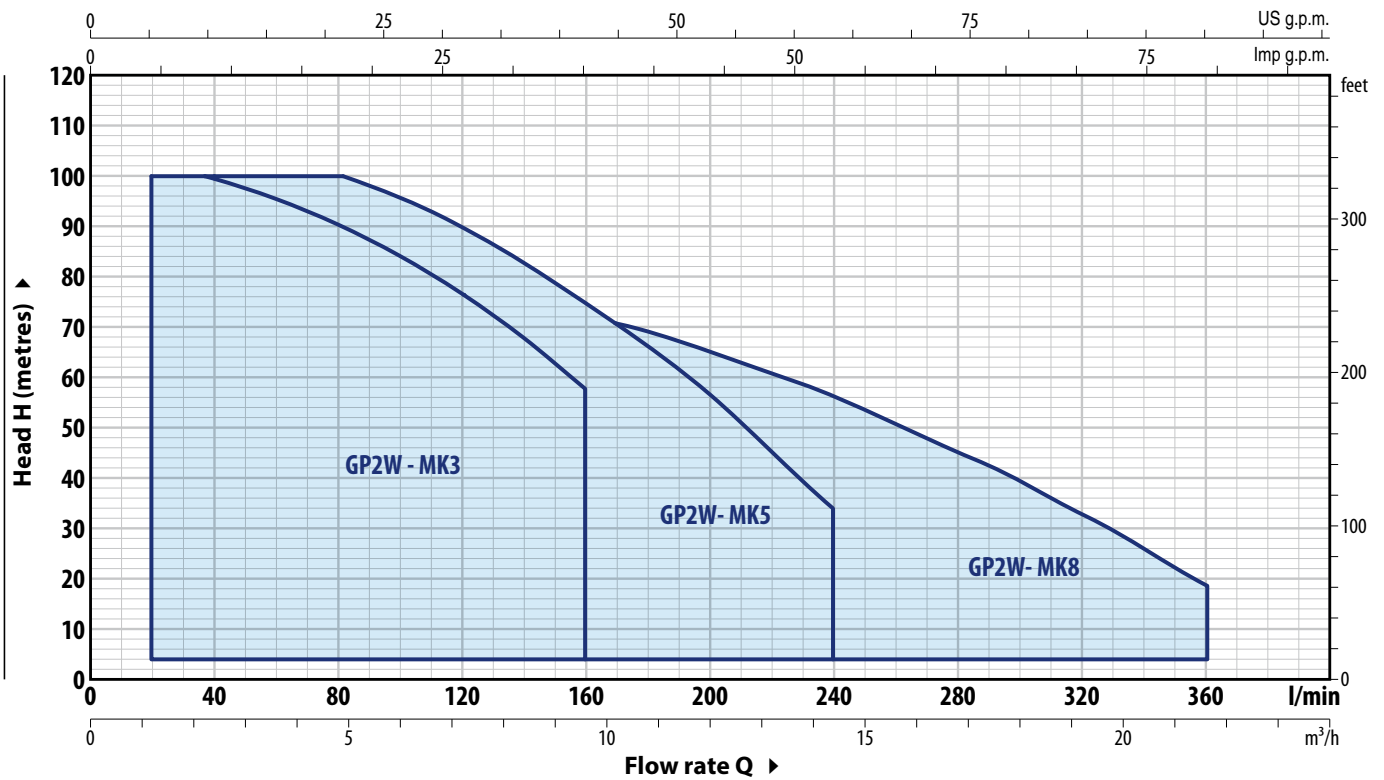

TYPE		POWER P ₂		Q	H metres												
Single-phase	Three-phase	kW	HP		0	1.2	2.4	4.8	7.2	9.6	12.0	14.7	16.8	19.2	21.6		
				0	20	40	80	120	160	200	240	280	320	360			
GP2Wm - MK 3/3	GP2W - MK 3/3	2x0.75	2x1	52.5	51.5	50	45	38.5	29								
GP2Wm - MK 3/5	GP2W - MK 3/5	2x1.1	2x1.5	87	85	83	75	64	48								
GP2Wm - MK 3/6	GP2W - MK 3/6	2x1.5	2x2	100	100	100	90	77	58								
GP2Wm - MK 5/4	GP2W - MK 5/4	2x0.75	2x1	57	-	54	50	45	37.5	28.5	17						
GP2Wm - MK 5/5	GP2W - MK 5/5	2x1.1	2x1.5	71	-	67.5	62.5	56	47	35.5	21.5						
GP2Wm - MK 5/7	GP2W - MK 5/7	2x1.5	2x2	99	-	95	88	78	66	50	30						
GP2Wm - MK 5/8	GP2W - MK 5/8	2x2.2	2x3	100	-	100	100	90	75	57	34						
GP2Wm - MK 8/4	GP2W - MK 8/4	2x1.1	2x1.5	56	-	-	53.5	51	47.5	43	37.5	30.5	22	12			
GP2Wm - MK 8/5	GP2W - MK 8/5	2x1.5	2x2	70	-	-	67	64	59.5	54	47	38	27.5	15.5			
GP2Wm - MK 8/6	GP2W - MK 8/6	2x2.2	2x3	84	-	-	80	77	72	64.5	56	45.5	33	18.5			

Q = Flow rate H = Total manometric head

✘ The data shown in the diagram and tables indicate performance with 2 pumps in operation

PERFORMANCE CURVES

50 Hz

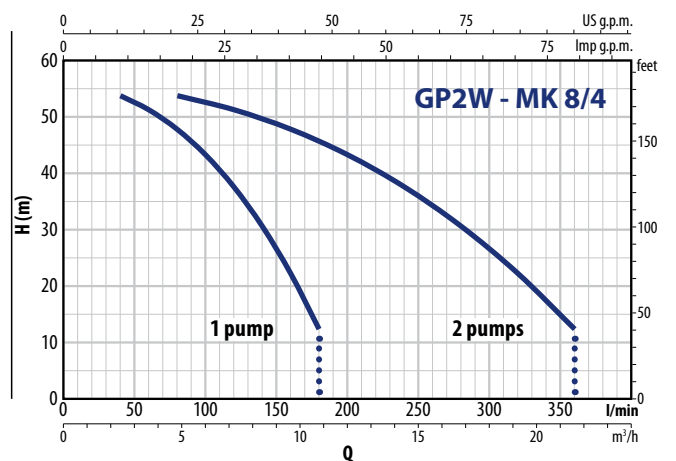
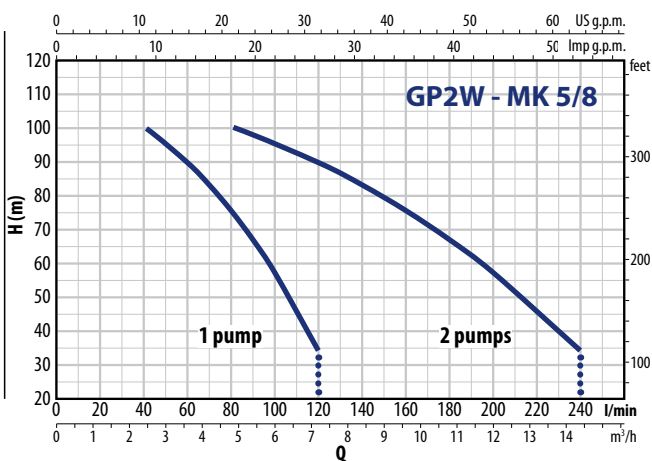
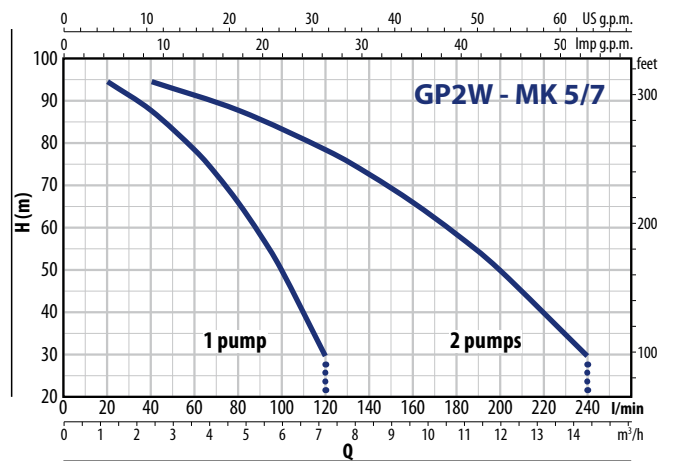
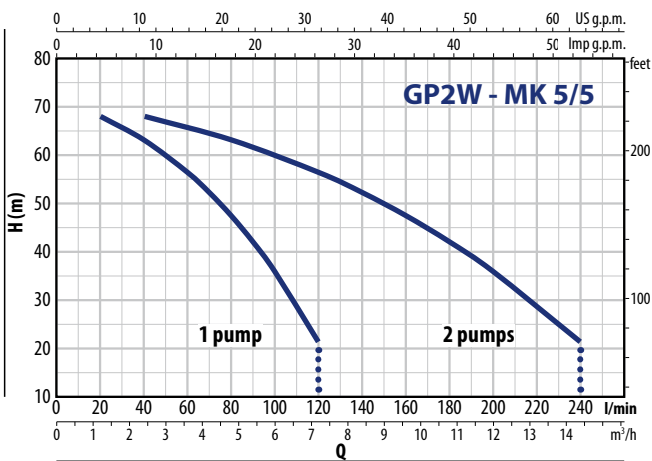
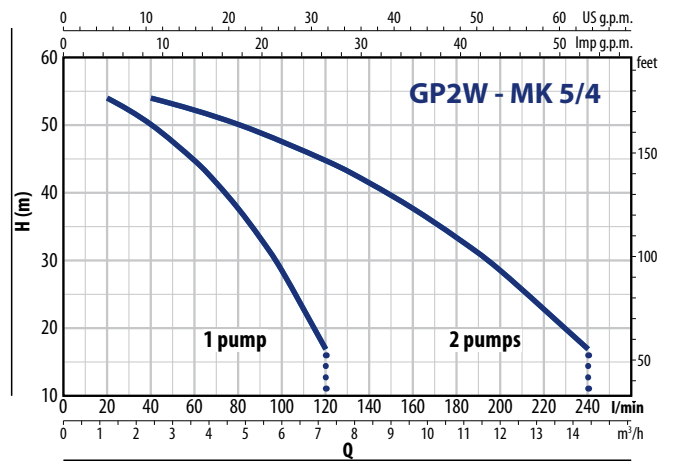
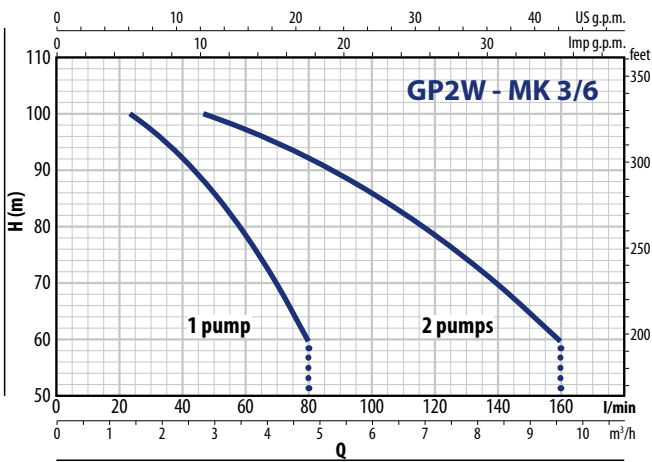
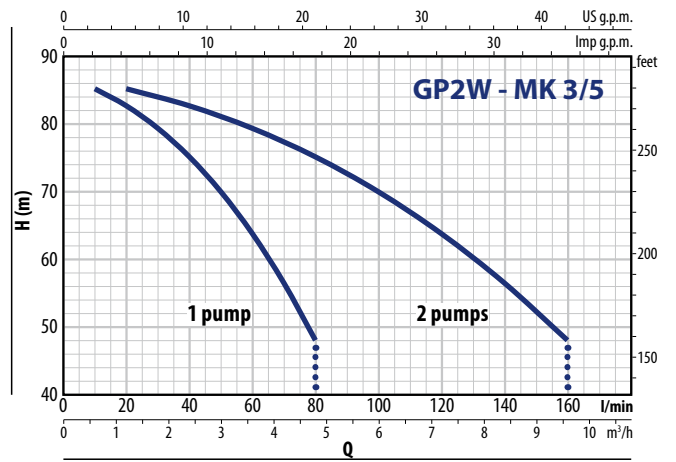
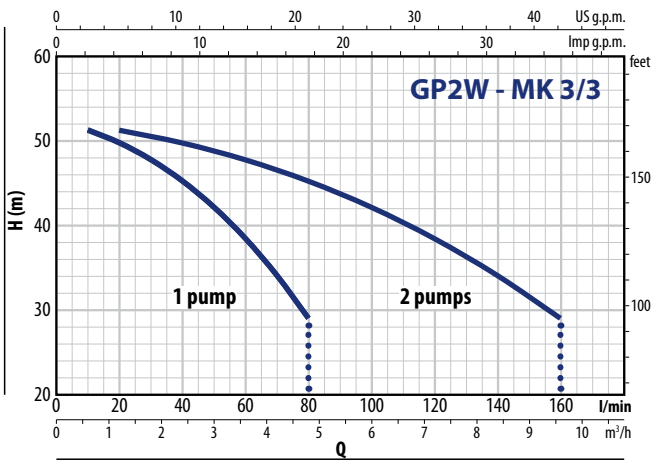

GP2W – MK

PERFORMANCE CURVES

50 Hz

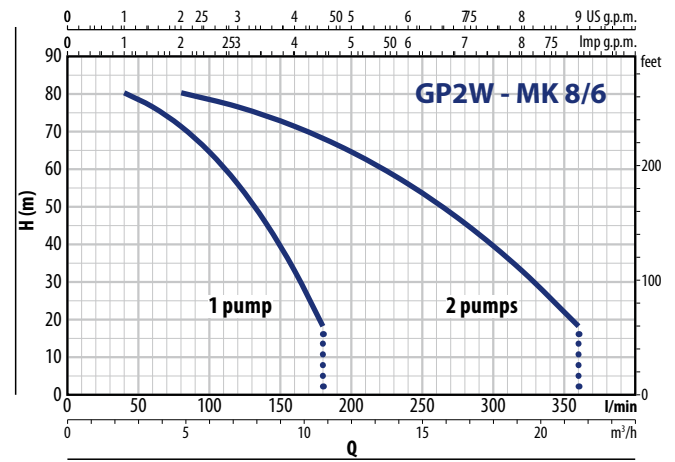
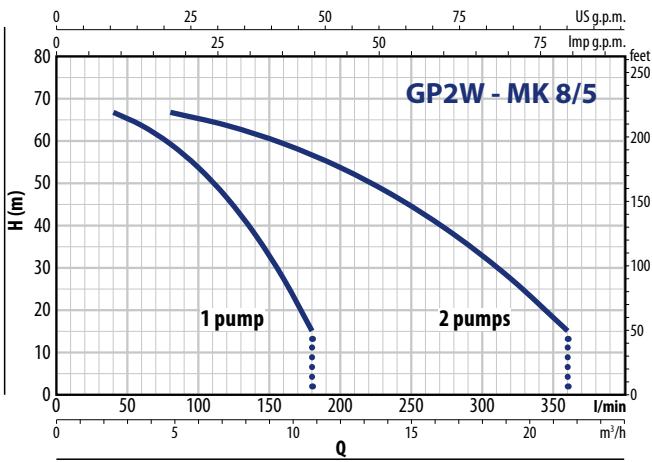

ABSORPTION

TYPE	VOLTAGE
Single-phase	230 V
GP2Wm - MK 3/3	2 x 9.0 A
GP2Wm - MK 3/5	2 x 12.5 A
GP2Wm - MK 3/6	2 x 14.0 A
GP2Wm - MK 5/4	2 x 9.0 A
GP2Wm - MK 5/5	2 x 11.0 A
GP2Wm - MK 5/7	2 x 13.5 A
GP2Wm - MK 5/8	2 x 16.0 A
GP2Wm - MK 8/4	2 x 12.5 A
GP2Wm - MK 8/5	2 x 14.0 A
GP2Wm - MK 8/6	2 x 18.0 A

TYPE	VOLTAGE
Three-phase	400 V
GP2W - MK 3/3	2 x 3.3 A
GP2W - MK 3/5	2 x 4.2 A
GP2W - MK 3/6	2 x 5.0 A
GP2W - MK 5/4	2 x 3.3 A
GP2W - MK 5/5	2 x 4.0 A
GP2W - MK 5/7	2 x 5.0 A
GP2W - MK 5/8	2 x 6.0 A
GP2W - MK 8/4	2 x 4.2 A
GP2W - MK 8/5	2 x 5.0 A
GP2W - MK 8/6	2 x 6.5 A

DIMENSIONS AND WEIGHT

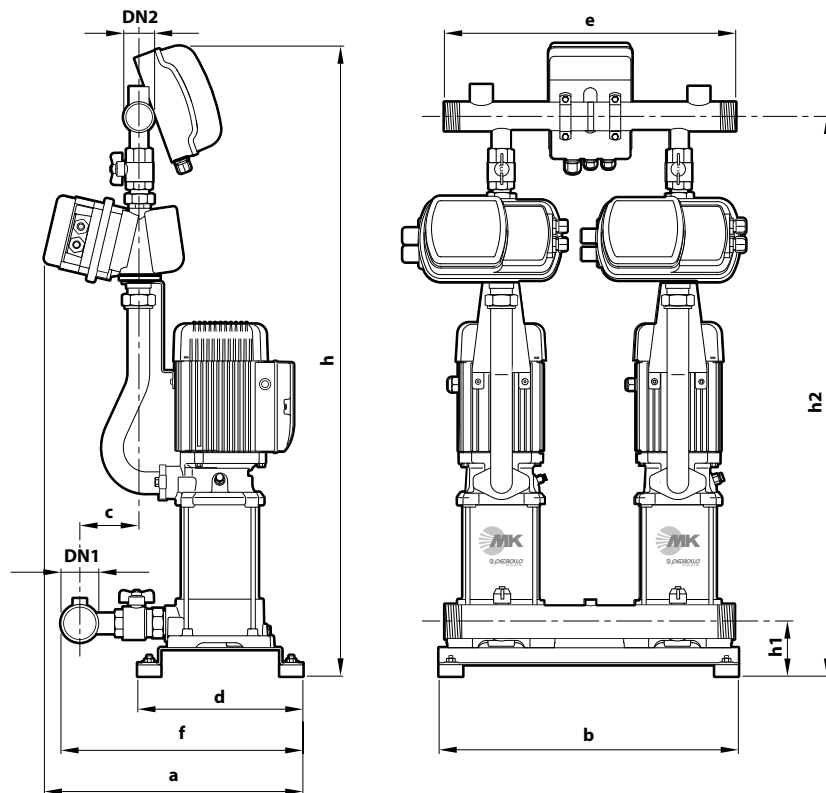

TYPE		PORTS		DIMENSIONS mm									kg	
Single-phase	Three-phase	DN1	DN2	a	b	c	d	e	f	h	h1	h2	1~	3~
GP2Wm - MK 3/3	GP2W - MK 3/3	2"	1½"	447	510	107	284	500	420	965	91	842	80.0	79.0
GP2Wm - MK 3/5	GP2W - MK 3/5									1019		896	84.0	84.0
GP2Wm - MK 3/6	GP2W - MK 3/6									1046		923	88.0	87.0
GP2Wm - MK 5/4	GP2W - MK 5/4									992		869	80.0	80.0
GP2Wm - MK 5/5	GP2W - MK 5/5									1019		896	83.0	83.0
GP2Wm - MK 5/7	GP2W - MK 5/7									1073		950	88.0	88.0
GP2Wm - MK 5/8	GP2W - MK 5/8									1100		977	89.0	88.0
GP2Wm - MK 8/4	GP2W - MK 8/4	2½"	2"						435	992		869	86.0	86.0
GP2Wm - MK 8/5	GP2W - MK 8/5									1019		896	87.0	86.0
GP2Wm - MK 8/6	GP2W - MK 8/6									1046		923	93.0	92.0

GP3W – MK

FIELD AND PERFORMANCE DATA

50 Hz

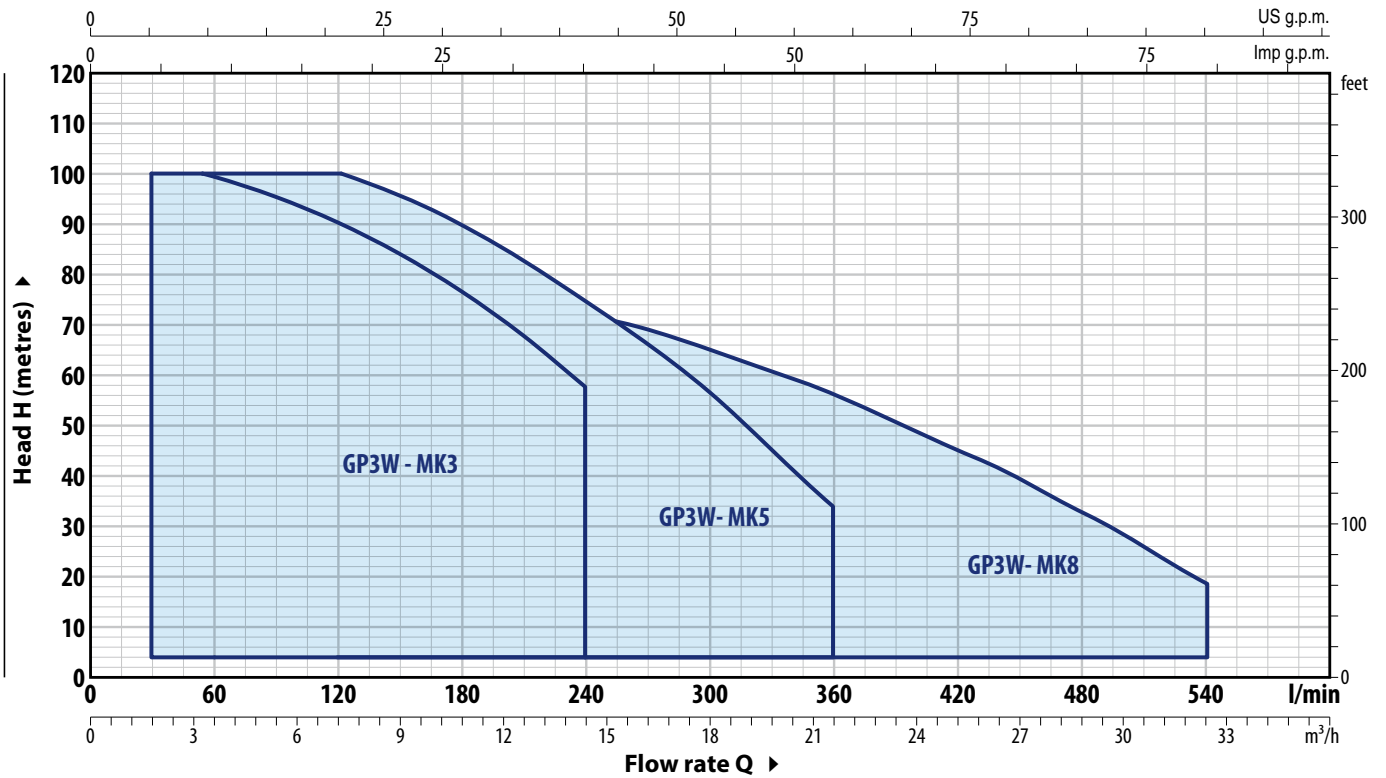

TYPE		POWER P ₂		Q	H metres											
Single-phase	Three-phase	kW	HP		m ³ /h	0	1.8	3.6	7.2	10.8	14.5	18.1	21.7	25.3	28.9	32.5
				l/min	0	30	60	120	180	240	300	360	420	480	540	
GP3Wm - MK 3/3	GP3W - MK 3/3	3x0.75	3x1	H metres	52.5	51.5	50	45	38.5	29						
GP3Wm - MK 3/5	GP3W - MK 3/5	3x1.1	3x1.5		87	85	83	75	64	48						
GP3Wm - MK 3/6	GP3W - MK 3/6	3x1.5	3x2		100	100	100	90	77	58						
GP3Wm - MK 5/4	GP3W - MK 5/4	3x0.75	3x1		57	-	54	50	45	37.5	28.5	17				
GP3Wm - MK 5/5	GP3W - MK 5/5	3x1.1	3x1.5		71	-	67.5	62.5	56	47	35.5	21.5				
GP3Wm - MK 5/7	GP3W - MK 5/7	3x1.5	3x2		99	-	95	88	78	66	50	30				
GP3Wm - MK 5/8	GP3W - MK 5/8	3x2.2	3x3		100	-	100	100	90	75	57	34				
GP3Wm - MK 8/4	GP3W - MK 8/4	3x1.1	3x2		56	-	-	53.5	51	47.5	43	37.5	30.5	22.1	12	
GP3Wm - MK 8/5	GP3W - MK 8/5	3x1.5	3x2.5		70	-	-	67	64	59.5	54	47	38	27.5	15.5	
GP3Wm - MK 8/6	GP3W - MK 8/6	3x2.2	3x3		84	-	-	80	77	72	64.5	56	45.5	33	18.5	

Q = Flow rate H = Total manometric head

✘ The data shown in the diagram and tables indicate performance with 3 pumps in operation

PERFORMANCE CURVES

50 Hz

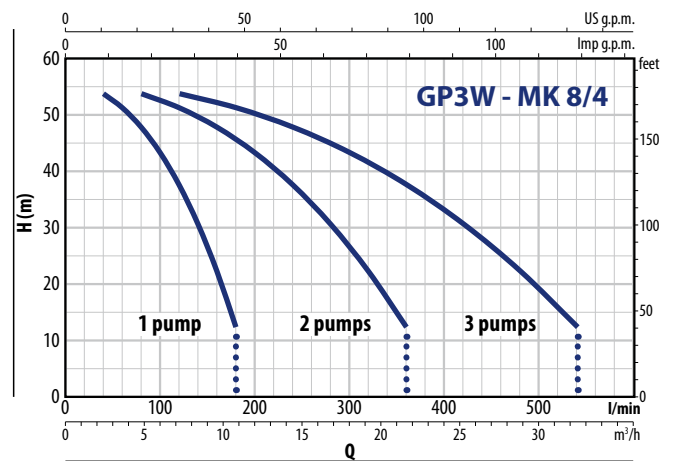
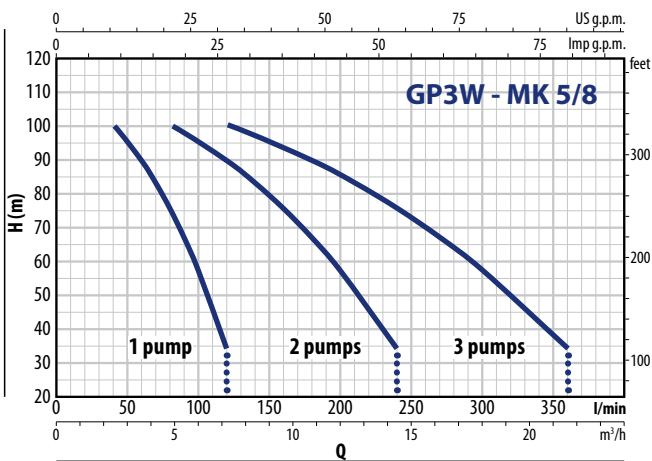
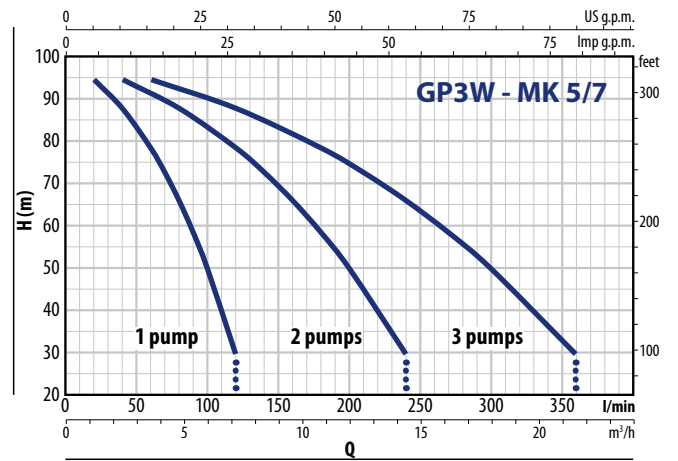
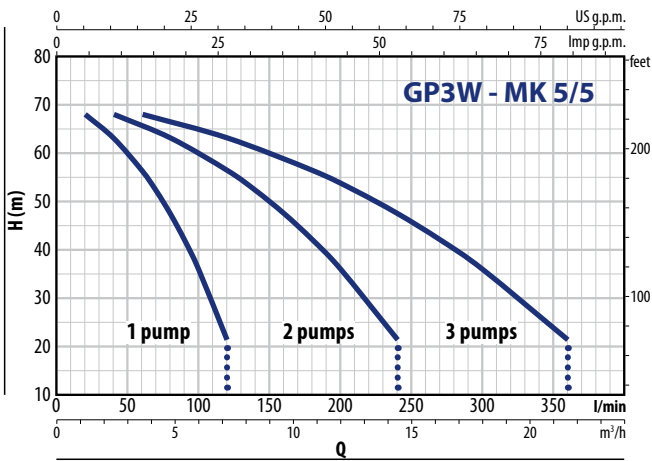
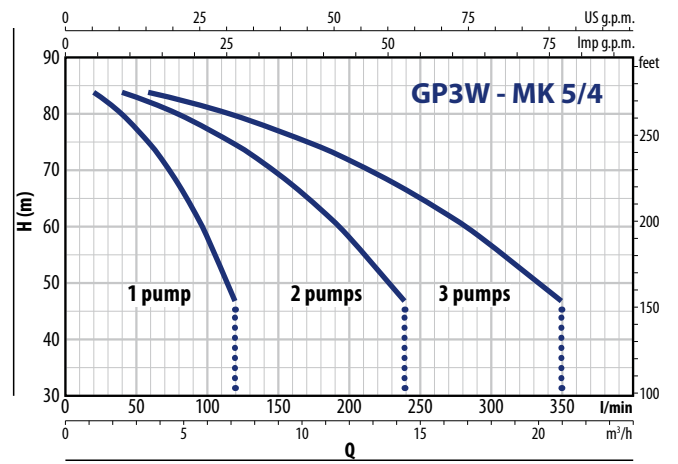
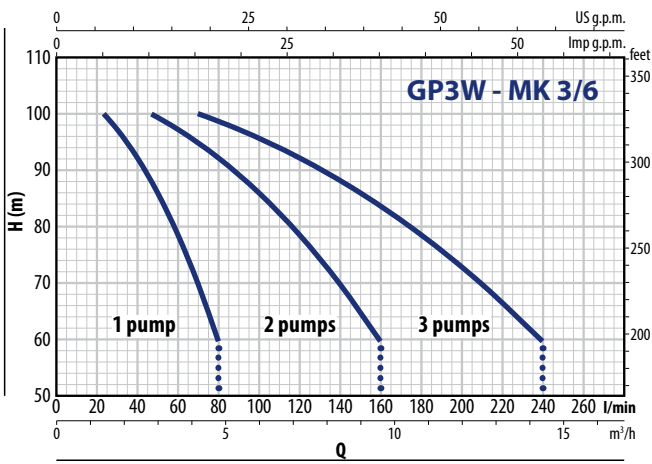
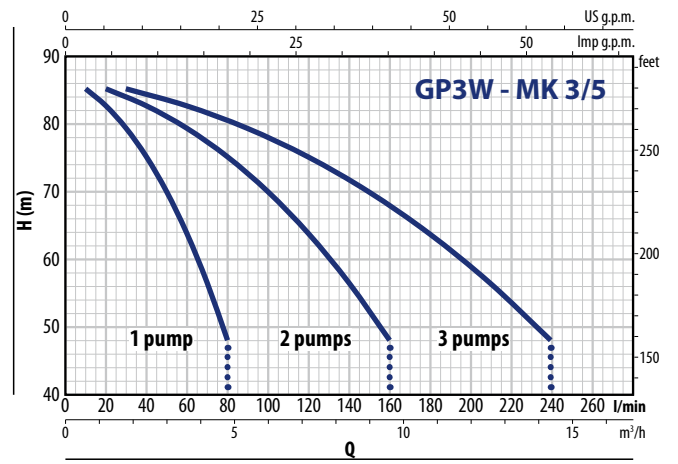
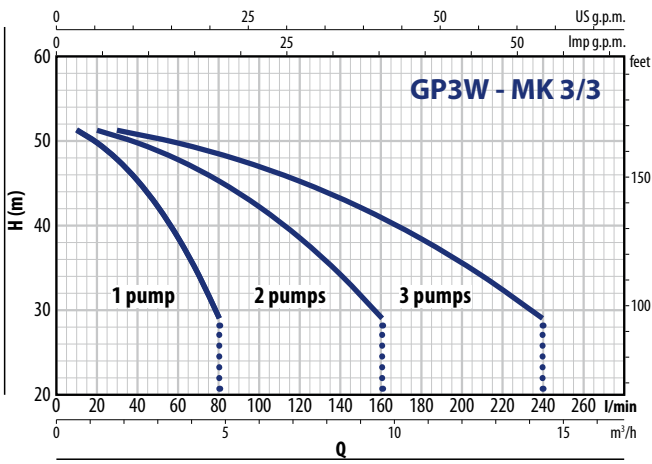

GP3W – MK

PERFORMANCE CURVES

50 Hz

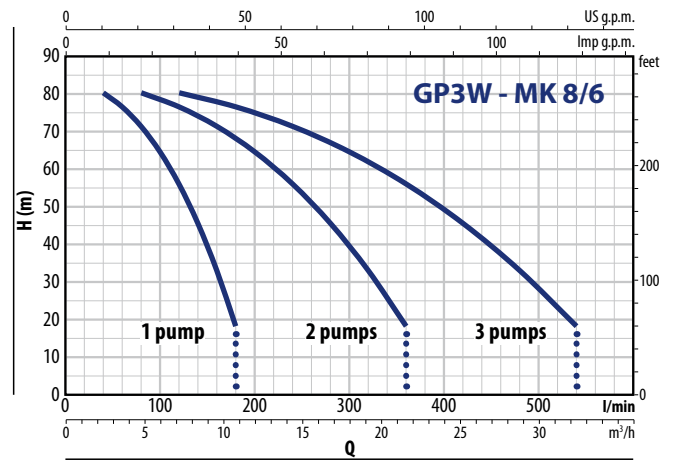
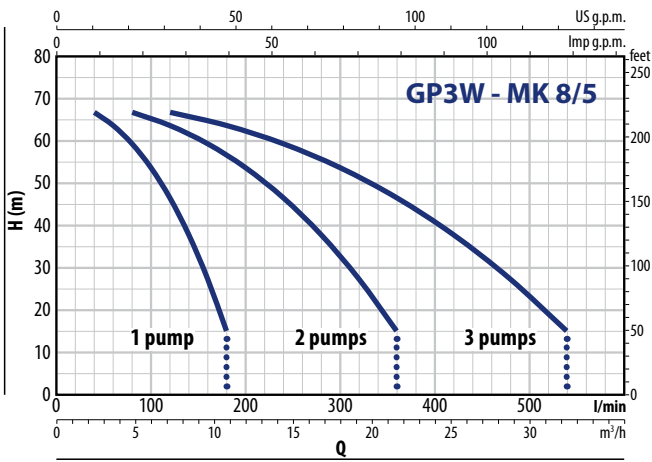

ABSORPTION

TYPE	VOLTAGE
Single-phase	230 V
GP3Wm - MK 3/3	3 x 9.0 A
GP3Wm - MK 3/5	3 x 12.5 A
GP3Wm - MK 3/6	3 x 14.0 A
GP3Wm - MK 5/4	3 x 9.0 A
GP3Wm - MK 5/5	3 x 11.0 A
GP3Wm - MK 5/7	3 x 13.5 A
GP3Wm - MK 5/8	3 x 16.0 A
GP3Wm - MK 8/4	3 x 12.5 A
GP3Wm - MK 8/5	3 x 14.0 A
GP3Wm - MK 8/6	3 x 18.0 A

TYPE	VOLTAGE
Three-phase	400 V
GP3W - MK 3/3	3 x 3.3 A
GP3W - MK 3/5	3 x 4.2 A
GP3W - MK 3/6	3 x 5.0 A
GP3W - MK 5/4	3 x 3.3 A
GP3W - MK 5/5	3 x 4.0 A
GP3W - MK 5/7	3 x 5.0 A
GP3W - MK 5/8	3 x 6.0 A
GP3W - MK 8/4	3 x 4.2 A
GP3W - MK 8/5	3 x 5.0 A
GP3W - MK 8/6	3 x 6.5 A

DIMENSIONS AND WEIGHT

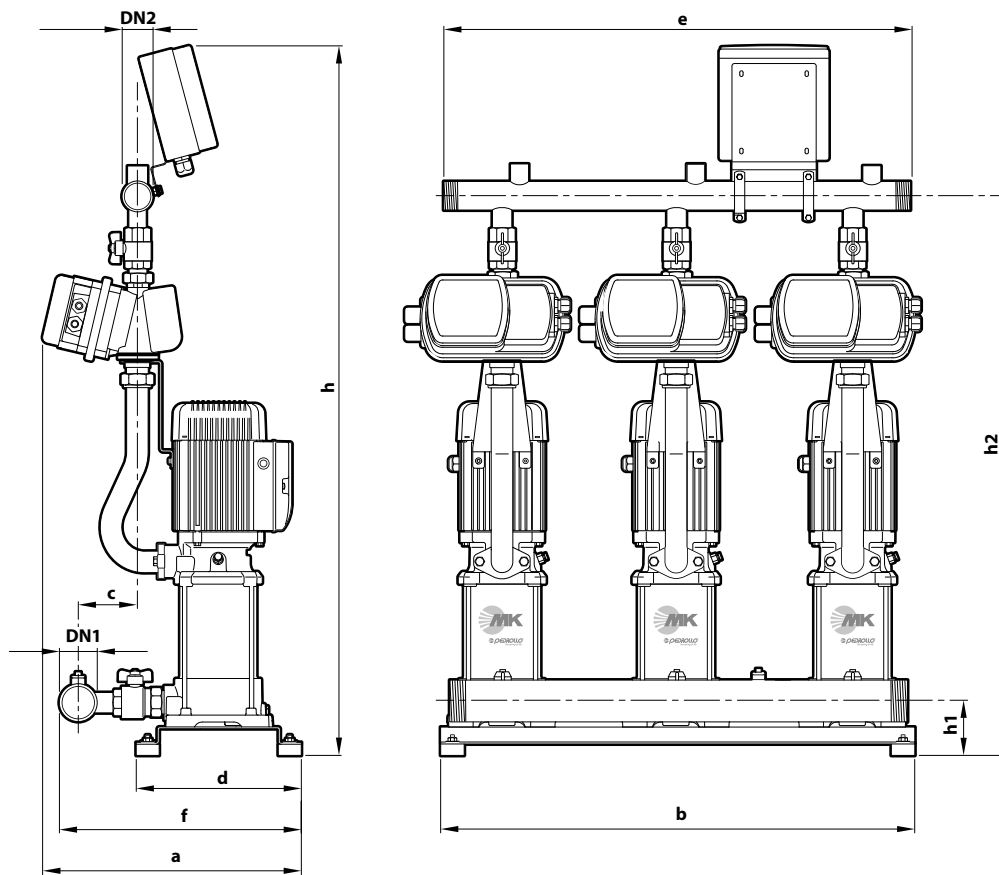

TYPE		PORTS		DIMENSIONS mm								kg		
Single-phase	Three-phase	DN1	DN2	a	b	c	d	e	f	h	h1	h2	1~	3~
GP3Wm - MK 3/3	GP3W - MK 3/3	2½"	2"	447	810	115	284	800	435	1143	91	849	123.0	124.0
GP3Wm - MK 3/5	GP3W - MK 3/5									1197		876	130.0	130.0
GP3Wm - MK 3/6	GP3W - MK 3/6									1224		930	135.0	136.0
GP3Wm - MK 5/4	GP3W - MK 5/4									1170		876	124.0	125.0
GP3Wm - MK 5/5	GP3W - MK 5/5									1197		903	129.0	130.0
GP3Wm - MK 5/7	GP3W - MK 5/7									1251		957	136.0	136.0
GP3Wm - MK 5/8	GP3W - MK 5/8									1278		984	140.0	140.0
GP3Wm - MK 8/4	GP3W - MK 8/4									1170		876	131.0	132.0
GP3Wm - MK 8/5	GP3W - MK 8/5									1197		903	132.0	133.0
GP3Wm - MK 8/6	GP3W - MK 8/6									1224		930	142.0	142.0