

-  Clean water
-  Civil use
-  Agricultural use
-  Industrial use

※ Pump entirely made of stainless steel



※ HT-PRO pumps are designed for high hydraulic performance combined with a robust, compact and reliable mechanical construction.

- ※ Pump body: **Stainless steel AISI 304**
- ※ Cover: **Stainless steel AISI 304**
- ※ Jacket: **Stainless steel AISI 304**
- ※ Impellers: **Stainless steel AISI 304**
- ※ Diffusers: **Stainless steel AISI 304**
- ※ Shaft: **Stainless steel AISI 431**

### PERFORMANCE RANGE

- Flow rate up to **800 l/min** (48 m<sup>3</sup>/h)
- Head up to **160 m**

### INSTALLATION AND USE

Designed to transfer clean water free from abrasive particles and liquids that will not damage the pump's components.

Their high efficiency and adaptability to a wide variety of applications make them an ideal choice in the domestic, civil, agricultural, and industrial sectors, particularly for water distribution along pressure tanks to increase overall network pressure. Suggested uses include fire-fighting systems, heavy-duty cleaning applications, industrial power washers, and irrigation.

### KEY FEATURES

- ※ The multi-stage stainless steel construction guarantees a long service life and a very low noise threshold during operation.
- ※ Stainless steel components extend service life and enhance efficiency.
- ※ Multi-stage design results in exceptionally quiet operation

### APPLICATION LIMITS

- Manometric suction head up to **7 m**
- Liquid temperature between **-15 °C** and **+90 °C**
- Ambient temperature up to **+40 °C**
- Maximum working pressure **16 bar**

### ELECTRIC MOTOR

The three-phase pumps are equipped with newly developed electric motors designed to work with inverters, which guarantee stable and quiet operation.

Efficiency class **IE3** for three-phase motors and **IE2** for single-phase motors, with class F insulation and IPX4 protection.

### AVAILABLE UPON REQUEST

- ※ AISI 316 stainless steel pump
- ※ Handling of liquids with higher or lower temperatures.
- ※ Pump body with NPT threaded ports ANSI B 1.20.1
- ※ Pump protection kit to prevent dry running
- ※ O-rings in EPDM or VITON (standard version in NBR)
- ※ Different voltage requirements 60 Hz frequency

## CURVES AND PERFORMANCE DATA – HS=0 m

50 Hz

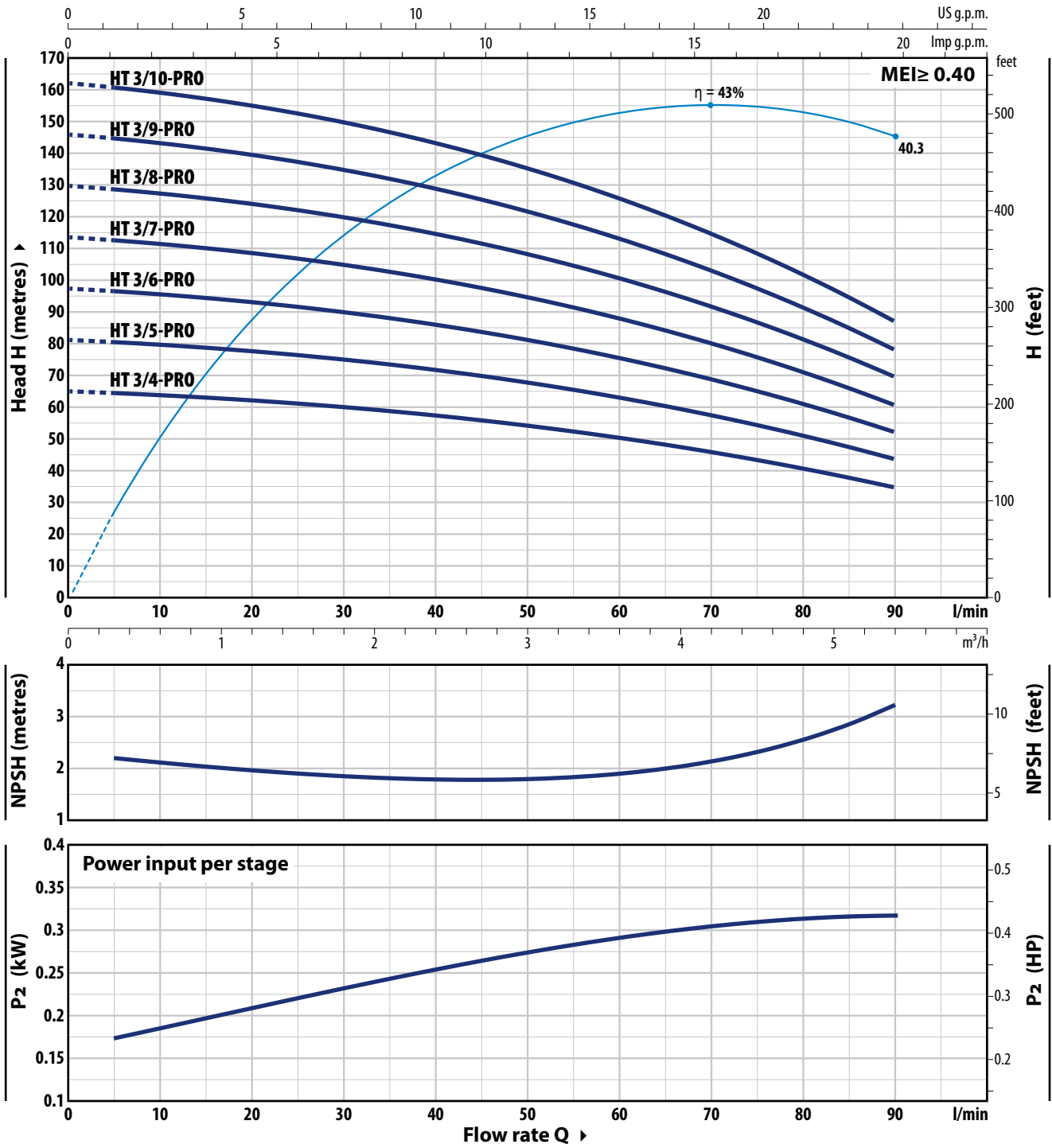

TYPE		POWER (P <sub>2</sub> )		1~3~	Q	Flow rate Q									
Single-phase	Three-phase	kW	HP			0	0.3	0.6	1.2	2.4	3.6	4.8	5.4		
HTm 3/4 - PRO	HT 3/4 - PRO	0.75	1	IE2 IE3	H metres	0	5	10	20	40	60	80	90		
HTm 3/5 - PRO	HT 3/5 - PRO	1.1	1.5			65	65	63.5	62	57	50	40.5	35		
HTm 3/6 - PRO	HT 3/6 - PRO	1.5	2			81	80	79	77	71	62.5	51	44		
HTm 3/7 - PRO	HT 3/7 - PRO	1.8	2.5			97	96	95	93	86	75	61	52		
※ -	HT 3/8 - PRO	2.2	3			113	112	111	108	100	88	71	61		
※ -	HT 3/9 - PRO	3	4			129	128	127	124	114	100	81	69.5		
※ -	HT 3/10 - PRO	3	4			146	144	143	139	129	113	91	78		

Q = Flow rate H = Total manometric head HS = Suction height

Performance curves comply with EN ISO 9906 Grade 3B tolerance limits.

# HT 5 - PRO

CURVES AND PERFORMANCE DATA – HS=0 m

50 Hz

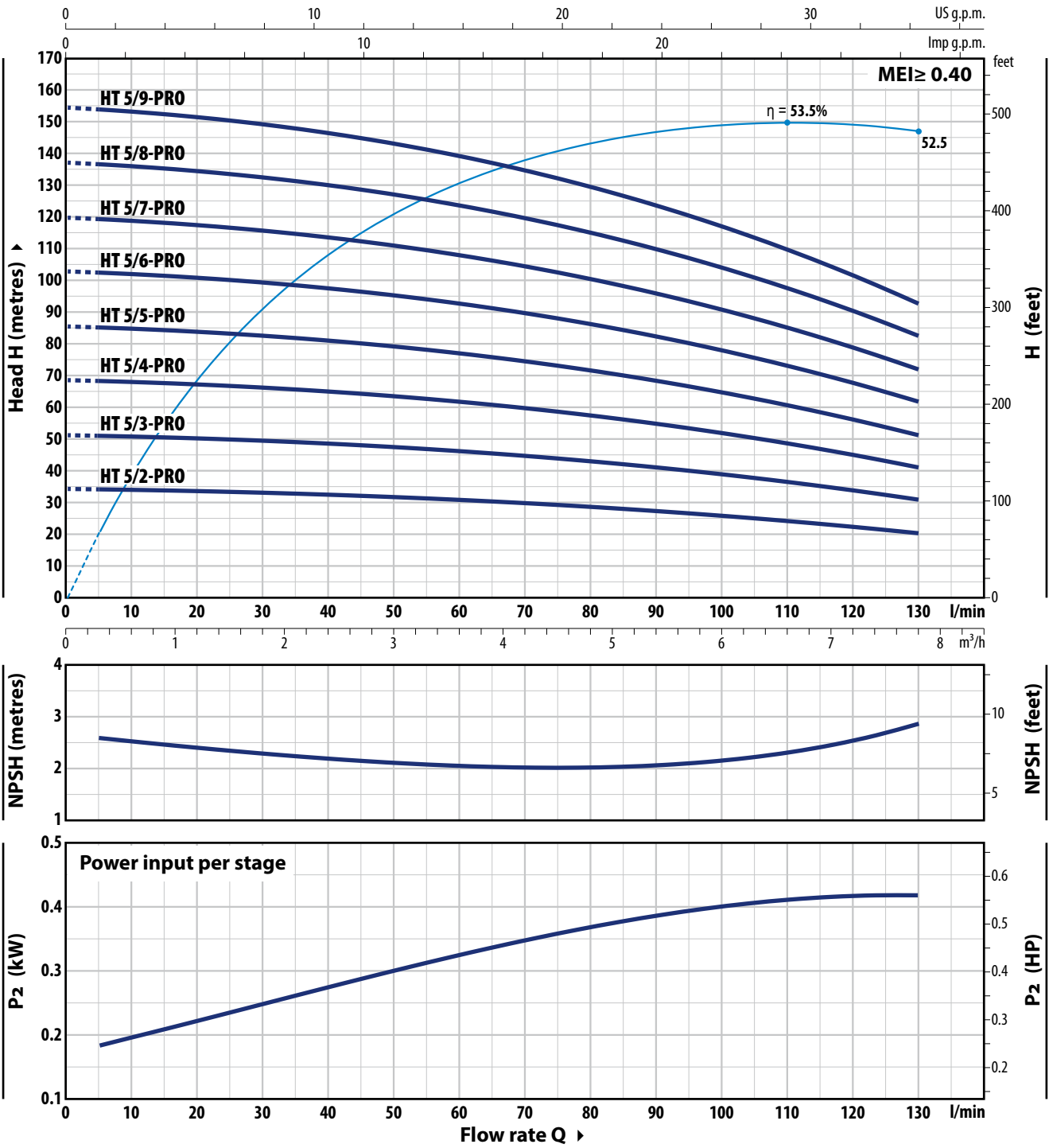

TYPE		POWER (P <sub>2</sub> )		1~3~	Q	m <sup>3</sup> /h												
Single-phase	Three-phase	kW	HP			0	0.3	0.6	1.2	2.4	3.6	4.8	5.4	6	7.8			
						0	5	10	20	40	60	80	90	100	130			
HTm 5/2 - PRO	HT 5/2 - PRO	0.75	1	IE2 IE3	H metres	35	35	32.7	32.3	32.5	31	25.5	27.5	26	20.5			
HTm 5/3 - PRO	HT 5/3 - PRO	1.1	1.5			51.5	51.5	51	50.5	49	46.5	43	41	39	31			
HTm 5/4 - PRO	HT 5/4 - PRO	1.5	2			68.5	68.5	68	67	65	62	57.5	55	52	41			
HTm 5/5 - PRO	HT 5/5 - PRO	1.8	2.5			86	85	85	84	81	77	72	68.5	65	51.5			
HTm 5/6 - PRO	HT 5/6 - PRO	2.2	3			103	103	102	101	98	93	86	82	78	62			
※ -	HT 5/7 - PRO	3	4			120	120	119	118	114	108	101	96	91	72			
※ -	HT 5/8 - PRO	3	4			137	137	136	134	130	124	115	110	104	82			
※ -	HT 5/9 - PRO	4	5.5			154	154	153	151	146	139	129	124	117	93			

Q = Flow rate H = Total manometric head HS = Suction height

Performance curves comply with EN ISO 9906 Grade 3B tolerance limits.

## CURVES AND PERFORMANCE DATA – HS=0 m

50 Hz

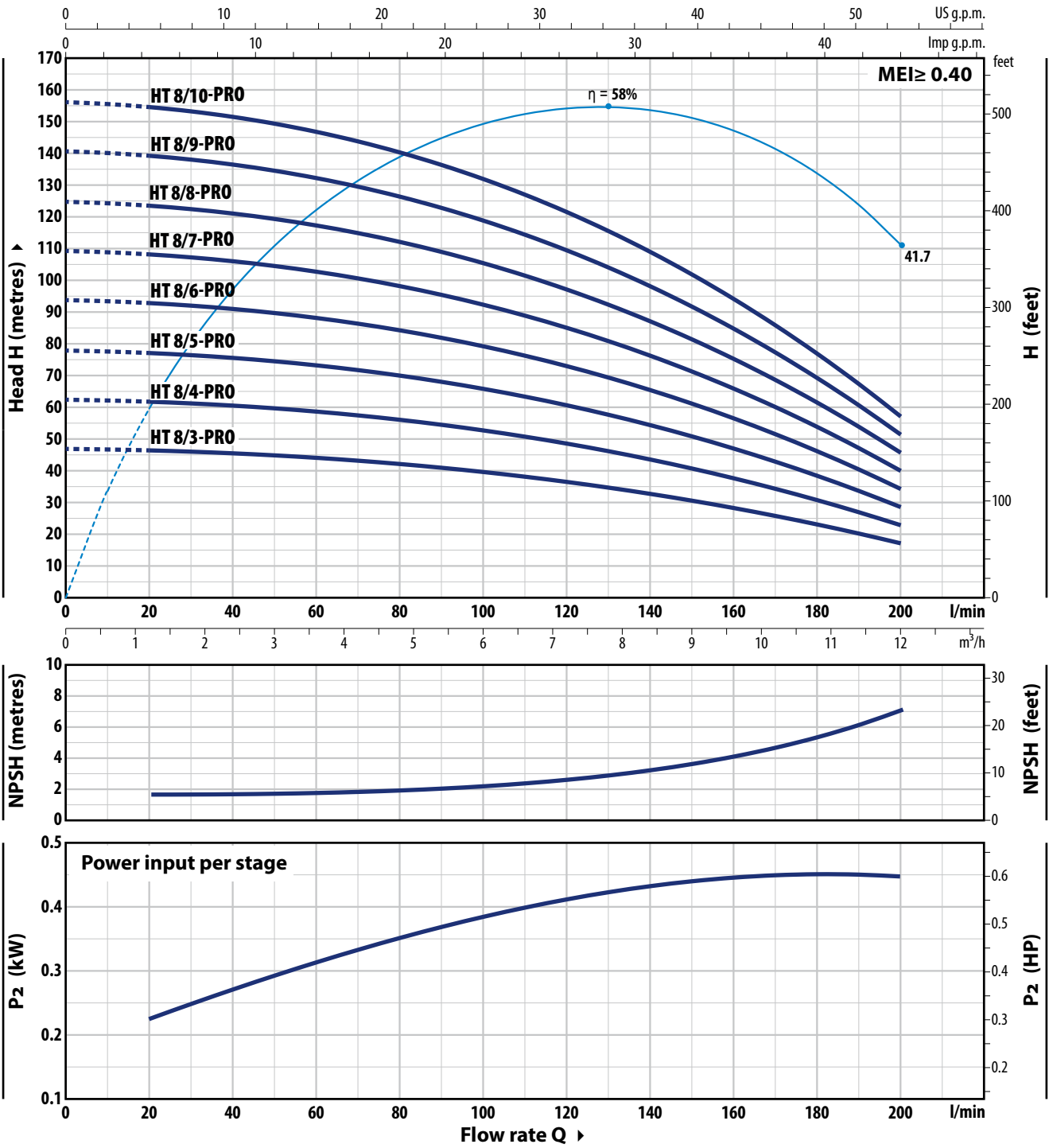

TYPE		POWER (P <sub>2</sub> )		1~3~	Q	H metres											
Single-phase	Three-phase	kW	HP			0	1.2	2.4	3.6	4.8	6.0	7.2	8.4	9.6	10.8	12.0	
					0	20	40	60	80	100	120	140	160	180	200		
HTm 8/3 - PRO	HT 8/3 - PRO	1.1	1.5	IE2 IE3	47	46.5	45.5	44	42	39.5	36.5	32.5	28	23	17		
HTm 8/4 - PRO	HT 8/4 - PRO	1.5	2		62.5	62	60.5	58.5	56	53	48.5	43.5	37.5	31	23		
HTm 8/5 - PRO	HT 8/5 - PRO	1.8	2.5		78	77.5	76	73	70	66	61	54.5	47	38.5	28.5		
HTm 8/6 - PRO	HT 8/6 - PRO	2.2	3		94	93	91	88	84	79	73	65.5	56.5	46	34.5		
※ -	HT 8/7 - PRO	3	4		109	108	106	103	98	92	85	76	66	54	40		
※ -	HT 8/8 - PRO	4	5.5		125	124	121	117	112	106	97	87	75	61.5	45.5		
※ -	HT 8/9 - PRO	4	5.5		141	139	136	132	126	119	109	98	85	69	51.5		
※ -	HT 8/10 - PRO	5.5	7.5		156	155	152	147	140	132	122	109	94	77	57		

Q = Flow rate H = Total manometric head HS = Suction height

Performance curves comply with EN ISO 9906 Grade 3B tolerance limits.

# HT 10 - PRO

CURVES AND PERFORMANCE DATA – HS=0 m

50 Hz

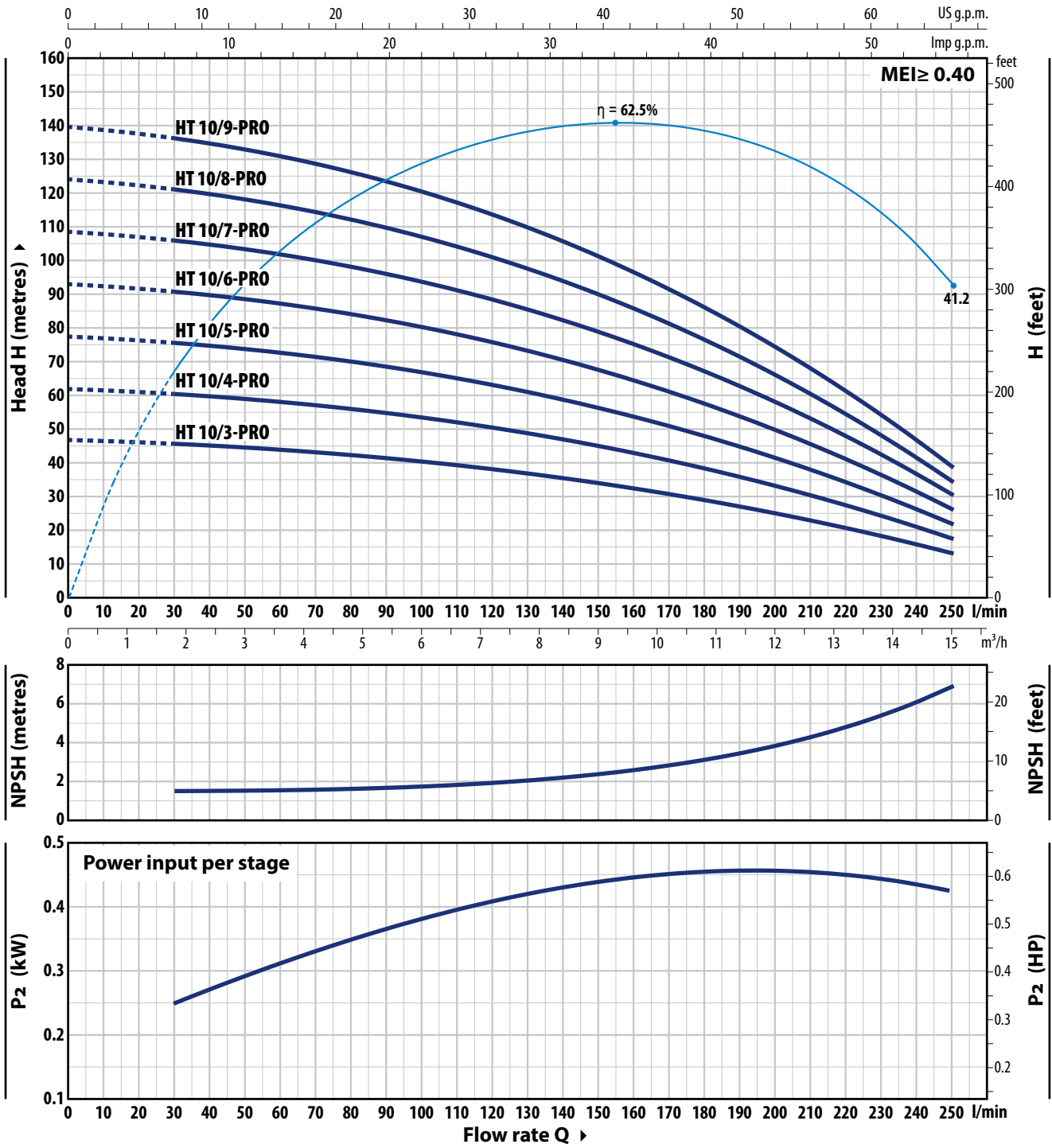

TYPE		POWER (P <sub>2</sub> )		1~3~	Q	Flow rate Q														
Single-phase	Three-phase	kW	HP			0	1.8	3	3.6	4.8	7.2	9	10.2	12	13.2	15				
					0	30	50	60	80	120	150	170	200	220	250					
HTm 10/3 - PRO	HT 10/3 - PRO	1.5	2	IE2 IE3	H metres	47	45.5	44	43.5	42	38	33.5	30.5	24.7	20.3	13				
HTm 10/4 - PRO	HT 10/4 - PRO	1.8	2.5			62	61	59	58	56	50.5	45	40.5	33	27	18				
HTm 10/5 - PRO	HT 10/5 - PRO	2.2	3			77	75.5	74	73	70	63	56	50.5	41	34	21.5				
-	HT 10/6 - PRO	3	4			93	91	88	87	84	76	67.5	61	49.5	40.5	26				
-	HT 10/7 - PRO	3	4			108	106	103	102	98	88	79	71	57.5	47.5	30				
-	HT 10/8 - PRO	4	5.5			124	121	118	116	112	101	90	81	66	54.5	34.5				
-	HT 10/9 - PRO	4	5.5			139	136	133	131	126	113	101	91	74	61	38.5				

Q = Flow rate H = Total manometric head HS = Suction height

Performance curves comply with EN ISO 9906 Grade 3B tolerance limits.

## CURVES AND PERFORMANCE DATA – HS=0 m

50 Hz

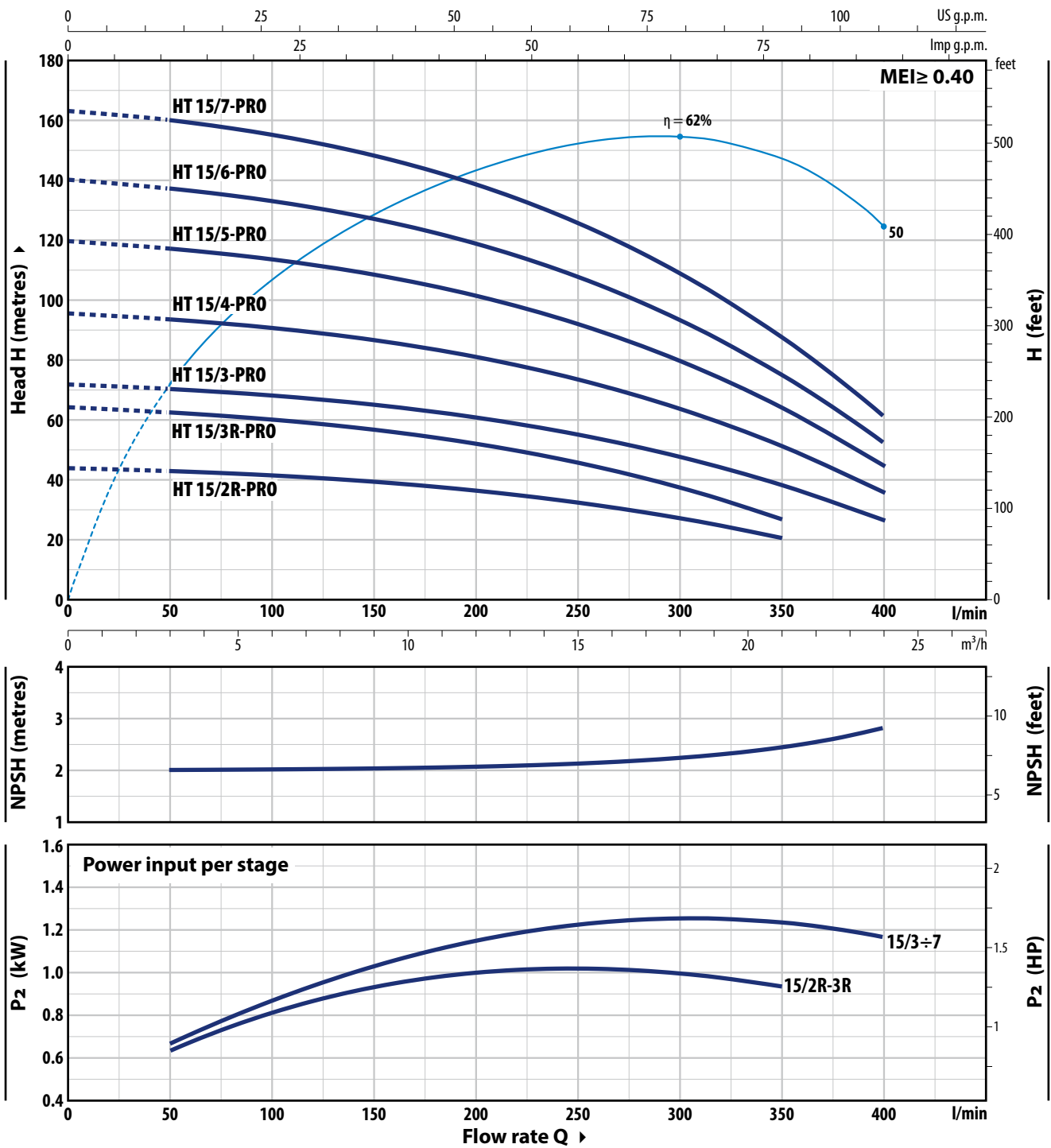

TYPE	POWER (P <sub>2</sub> )		3~	Q	Flow rate													
	kW	HP			0	3	6	12	18	21	24	0	50	100	200	300	350	400
HT 15/2R - PRO	2.2	3	IE3	H metres	44	43	41.5	36.5	27.5	20.5								
HT 15/3R - PRO	3	4			64.5	62.5	60.5	52.0	37.5	27								
HT 15/3 - PRO	4	5.5			72	70	68.5	61	48	38.5	27							
HT 15/4 - PRO	5.5	7.5			96	94	91	81	64	51.5	36							
HT 15/5 - PRO	7.5	10			120	117	114	102	80	64.5	45							
HT 15/6 - PRO	9.2	12.5			140	137	133	119	94	75.5	52.5							
HT 15/7 - PRO	9.2	12.5			-	160	155	139	109	88	61.5							

Q = Flow rate H = Total manometric head HS = Suction height

Performance curves comply with EN ISO 9906 Grade 3B tolerance limits.

# HT 30 - PRO

CURVES AND PERFORMANCE DATA – HS=0 m

50 Hz

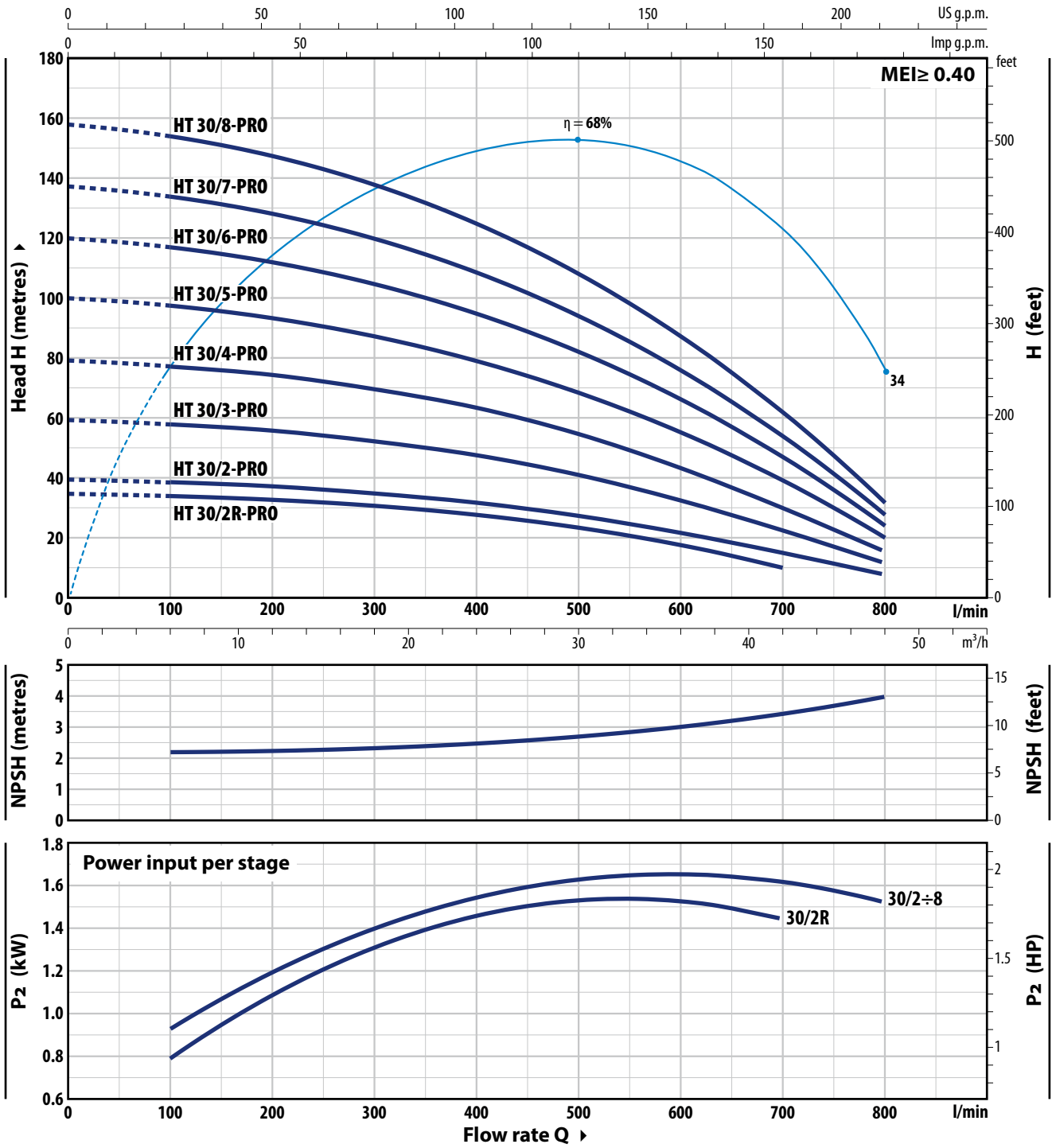

TYPE	POWER (P <sub>2</sub> )		3~	Q	m <sup>3</sup> /h											
	kW	HP			0	6	12	18	24	36	42	48				
Three-phase					0	100	200	300	400	600	700	800				
HT 30/2R - PRO	3	4	IE3	H metres	35	34	33	31	28	17.6	10					
HT 30/2 - PRO	4	5.5			40	39	37.5	35	31.5	22	15.7	8				
HT 30/3 - PRO	5.5	7.5			60	58.5	56	52.5	47.5	33	23.5	12				
HT 30/4 - PRO	7.5	10			80	78	75	70	63	44	31.3	16				
HT 30/5 - PRO	9.2	12.5			100	98	93	87	79	55	39	20				
HT 30/6 - PRO	11	15			120	117	112	105	95	66.5	47	24				
HT 30/7 - PRO	15	20			137	134	128	120	108	76	53.5	27.5				
HT 30/8 - PRO	15	20			158	154	147	138	125	87	62	31.5				

Q = Flow rate H = Total manometric head HS = Suction height

Performance curves comply with EN ISO 9906 Grade 3B tolerance limits.

## ABSORPTION

TYPE	VOLTAGE
<b>Single-phase</b>	<b>230 V</b>
HTm 3/4 - PRO	7.5 A
HTm 3/5 - PRO	9.0 A
HTm 3/6 - PRO	10.5 A
HTm 3/7 - PRO	12.5 A
HTm 5/2 - PRO	6.1 A
HTm 5/3 - PRO	8.5 A
HTm 5/4 - PRO	10.3 A
HTm 5/5 - PRO	12.5 A
HTm 5/6 - PRO	13.5 A
HTm 8/3 - PRO	8.7 A
HTm 8/4 - PRO	10.5 A
HTm 8/5 - PRO	12.5 A
HTm 8/6 - PRO	14.0 A
HTm 10/3 - PRO	9.5 A
HTm 10/4 - PRO	11.0 A
HTm 10/5 - PRO	13.5 A

TYPE	VOLTAGE			
	230 V - Δ	400 V - 人	400 V - Δ	690 V - 人
HT 3/4 - PRO	5.2 A	3.0 A	-	-
HT 3/5 - PRO	6.1 A	3.5 A	-	-
HT 3/6 - PRO	6.9 A	4.0 A	-	-
HT 3/7 - PRO	8.3 A	4.8 A	-	-
HT 3/8 - PRO	11.2 A	6.5 A	-	-
HT 3/9 - PRO	11.8 A	6.8 A	-	-
HT 3/10 - PRO	12.1 A	7.0 A	-	-
HT 5/2 - PRO	4.9 A	2.8 A	-	-
HT 5/3 - PRO	5.5 A	3.2 A	-	-
HT 5/4 - PRO	6.6 A	3.8 A	-	-
HT 5/5 - PRO	8.3 A	4.8 A	-	-
HT 5/6 - PRO	9.0 A	5.2 A	-	-
HT 5/7 - PRO	11.8 A	6.8 A	-	-
HT 5/8 - PRO	13.0 A	7.5 A	-	-
HT 5/9 - PRO	14.7 A	8.5 A	-	-
HT 8/3 - PRO	5.7 A	3.3 A	-	-
HT 8/4 - PRO	6.9 A	4.0 A	-	-
HT 8/5 - PRO	8.3 A	4.8 A	-	-
HT 8/6 - PRO	9.3 A	5.4 A	-	-
HT 8/7 - PRO	12.1 A	7.0 A	-	-
HT 8/8 - PRO	14.7 A	8.5 A	-	-
HT 8/9 - PRO	16.4 A	9.5 A	-	-
HT 8/10 - PRO	-	-	10.5 A	6.1 A
HT 10/3 - PRO	5.9 A	3.4 A	-	-
HT 10/4 - PRO	7.8 A	4.5 A	-	-
HT 10/5 - PRO	9.0 A	5.2 A	-	-
HT 10/6 - PRO	11.2 A	6.5 A	-	-
HT 10/7 - PRO	12.5 A	7.2 A	-	-
HT 10/8 - PRO	14.4 A	8.3 A	-	-
HT 10/9 - PRO	15.6 A	9.0 A	-	-
HT 15/2R - PRO	10.4 A	6.0 A	-	-
HT 15/3R - PRO	12.5 A	7.2 A	-	-
HT 15/3 - PRO	15.2 A	8.8 A	-	-
HT 15/4 - PRO	-	-	11.2 A	6.5 A
HT 15/5 - PRO	-	-	14.2 A	8.2 A
HT 15/6 - PRO	-	-	15.0 A	8.7 A
HT 15/7 - PRO	-	-	16.5 A	9.5 A
HT 30/2R - PRO	12.1 A	7.0 A	-	-
HT 30/2 - PRO	15.2 A	8.8 A	-	-
HT 30/3 - PRO	-	-	11.2 A	6.5 A
HT 30/4 - PRO	-	-	14.1 A	8.2 A
HT 30/5 - PRO	-	-	16.5 A	9.5 A
HT 30/6 - PRO	-	-	19.0 A	11.0 A
HT 30/7 - PRO	-	-	22.0 A	12.7 A
HT 30/8 - PRO	-	-	24.5 A	14.2 A

## PALLET CAPACITY

TYPE		NO. OF PUMPS
Single-phase	Three-phase	
HTm 3/4 - PRO	HT 3/4 - PRO	12
HTm 3/5 - PRO	HT 3/5 - PRO	12
HTm 3/6 - PRO	HT 3/6 - PRO	12
HTm 3/7 - PRO	HT 3/7 - PRO	12
HTm 3/8 - PRO	HT 3/8 - PRO	4
-	HT 3/9 - PRO	4
-	HT 3/10 - PRO	4
HTm 5/2 - PRO	HT 5/2 - PRO	12
HTm 5/3 - PRO	HT 5/3 - PRO	12
HTm 5/4 - PRO	HT 5/4 - PRO	12
HTm 5/5 - PRO	HT 5/5 - PRO	12
HTm 5/6 - PRO	HT 5/6 - PRO	12
-	HT 5/7 - PRO	4
-	HT 5/8 - PRO	4
-	HT 5/9 - PRO	4
HTm 8/3 - PRO	HT 8/3 - PRO	12
HTm 8/4 - PRO	HT 8/4 - PRO	12
HTm 8/5 - PRO	HT 8/5 - PRO	12
HTm 8/6 - PRO	HT 8/6 - PRO	12
-	HT 8/7 - PRO	4
-	HT 8/8 - PRO	4
-	HT 8/9 - PRO	4
-	HT 8/10 - PRO	4
HTm 10/3 - PRO	HT 10/3 - PRO	12
HTm 10/4 - PRO	HT 10/4 - PRO	12
HTm 10/5 - PRO	HT 10/5 - PRO	12
-	HT 10/6 - PRO	12
-	HT 10/7 - PRO	4
-	HT 10/8 - PRO	4
-	HT 10/9 - PRO	4
-	HT 15/2R - PRO	4
-	HT 15/3R - PRO	4
-	HT 15/3 - PRO	4
-	HT 15/4 - PRO	4
-	HT 15/5 - PRO	4
-	HT 15/6 - PRO	2
-	HT 15/7 - PRO	2
-	HT 30/2R - PRO	4
-	HT 30/2 - PRO	4
-	HT 30/3 - PRO	4
-	HT 30/4 - PRO	4
-	HT 30/5 - PRO	2
-	HT 30/6 - PRO	2
-	HT 30/7 - PRO	2
-	HT 30/8 - PRO	2



### DIMENSIONS AND WEIGHT

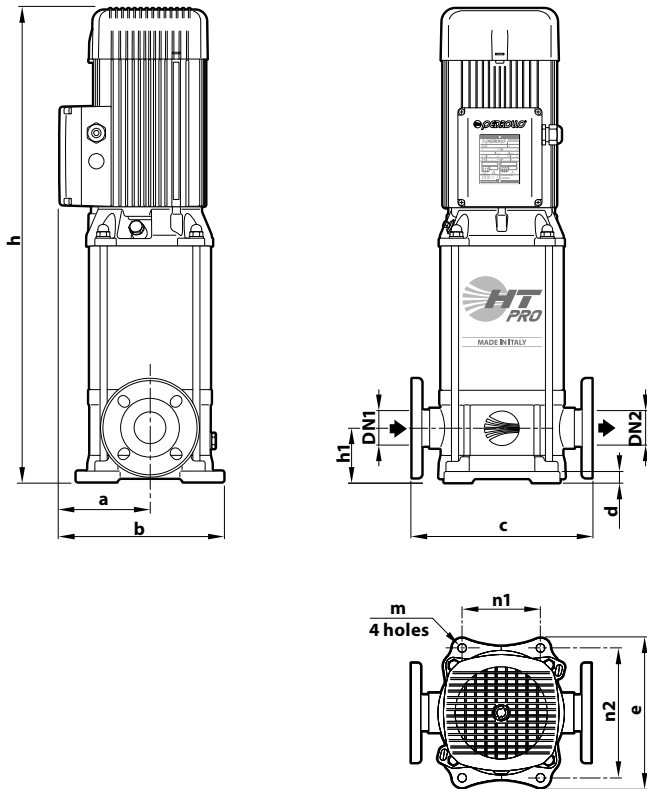

### FLANGE

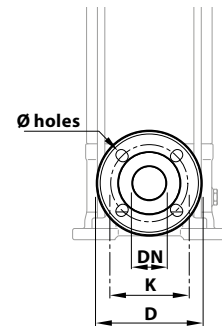

TYPE	DN mm	D mm	K mm	HOLES	
				N°	Ø mm
HT 3 - PRO	25	115	85	4	14
HT 5 - PRO	32	140	100		
HT 8 - PRO	40	150	110		
HT 10 - PRO	40	150	110		
HT 15 - PRO	50	165	125		
HT 30 - PRO	65	185	145	18	

TYPE		PORTS		N°	DIMENSIONS mm										kg												
Single-phase	Three-phase	DN1	DN2	STAGES	a	b	c	d	e	h	h1	n1	n2	m	1~	3~											
HTm 3/4 - PRO	HT 3/4 - PRO	1"	1"	4	126	231	250	15	210	509	75	100	180	Ø 13	31.5	31.5											
HTm 3/5 - PRO	HT 3/5 - PRO			5						31.7					31.7												
HTm 3/6 - PRO	HT 3/6 - PRO			6						33.0					33.0												
HTm 3/7 - PRO	HT 3/7 - PRO			7						37.9					37.9												
-	HT 3/8 - PRO			8						-					45.2												
-	HT 3/9 - PRO			9						-					46.2												
-	HT 3/10 - PRO			10						-					47.1												
HTm 5/2 - PRO	HT 5/2 - PRO			2						1 1/4"					1 1/4"	126	231	250	15	210	457	75	100	180	Ø 13	29.9	29.9
HTm 5/3 - PRO	HT 5/3 - PRO			3																	30.1					30.1	
HTm 5/4 - PRO	HT 5/4 - PRO			4																	32.1					32.1	
HTm 5/5 - PRO	HT 5/5 - PRO	5	34.5	34.5																							
HTm 5/6 - PRO	HT 5/6 - PRO	6	35.5	35.5																							
-	HT 5/7 - PRO	7	-	44.3																							
-	HT 5/8 - PRO	8	-	45.3																							
-	HT 5/9 - PRO	9	-	49.5																							
HTm 8/3 - PRO	HT 8/3 - PRO	3	1 1/2"	1 1/2"	126	231	280	15	210		488	80	100	180							Ø 13					30.6	30.6
HTm 8/4 - PRO	HT 8/4 - PRO	4									32.6															32.6	
HTm 8/5 - PRO	HT 8/5 - PRO	5								36.1	36.1																
HTm 8/6 - PRO	HT 8/6 - PRO	6								36.9	36.9																
-	HT 8/7 - PRO	7								-	44.6																
-	HT 8/8 - PRO	8								-	48.7																
-	HT 8/9 - PRO	9								-	49.7																
-	HT 8/10 - PRO	10								-	54.7																
HTm 10/3 - PRO	HT 10/3 - PRO	3								1 1/2"	1 1/2"				126	231	280	15	210	488		80	100	180	Ø 13	30.7	30.7
HTm 10/4 - PRO	HT 10/4 - PRO	4																		32.7						32.7	
HTm 10/5 - PRO	HT 10/5 - PRO	5	36.2	36.2																							
-	HT 10/6 - PRO	6	-	44.5																							
-	HT 10/7 - PRO	7	-	44.7																							
-	HT 10/8 - PRO	8	-	48.8																							
-	HT 10/9 - PRO	9	-	49.8																							
-	HT 15/2R - PRO	2	2"	2"	151	275	300	18	247			589	90	130						215	Ø 14					-	52.0
-	HT 15/3R - PRO	3										-														52.5	
-	HT 15/3 - PRO	3										-														57.0	
-	HT 15/4 - PRO	4								-	63.0																
-	HT 15/5 - PRO	5								-	71.0																
-	HT 15/6 - PRO	6								-	115.5																
-	HT 15/7 - PRO	7								-	116.0																
-	HT 30/2R - PRO	2								2 1/2"	2 1/2"	151			275	320	18	247	604			105	130	215	Ø 14	-	53.5
-	HT 30/2 - PRO	2																	-							56.5	
-	HT 30/3 - PRO	3																	-							61.5	
-	HT 30/4 - PRO	4	-	70.0																							
-	HT 30/5 - PRO	5	-	123.5																							
-	HT 30/6 - PRO	6	-	124.0																							
-	HT 30/7 - PRO	7	-	136.5																							
-	HT 30/8 - PRO	8	-	137.0																							

## MATERIALS AND COMPONENTS

**1 Pump body** Stainless steel **AISI 304**, provided with ISO 228/1 threaded ports

**2 Cover** Stainless steel **AISI 304**

**3 External sleeve** Stainless steel **AISI 304**

**4 Impellers** Stainless steel **AISI 304**

**5 Diffusers** Stainless steel **AISI 304**

### 6 Mechanical seal

Water pump	Seal	Shaft	Materials
HT 3 - 5 - 8 - 10 PRO	<b>FN-18</b>	Ø 18 mm	Graphite / Ceramic / NBR
HT 15 - 30 PRO	<b>FN-KU-24</b>	Ø 24 mm	Graphite / Ceramic / NBR
	ISO 3069 EN 12756		

**7 Shaft** Stainless steel **AISI 316L**

### 8 Electric motor

- **HTm - PRO**: single-phase 230 V - 50 Hz with capacitor and winding integrated thermal motor protection
- **HT - PRO**: three-phase  
230/400 V - 50 Hz up to 4 kW  
400/690 V - 50 Hz from 5.5 to 15 kW

※ Pumps are equipped with high-efficiency motors (IEC 60034-30-1)  
class **IE2** for single-phase models  
class **IE3** for three-phase models

Continuous running duty **S1**

